

Leica BLK360

User Manual



Version 1.0
English

- when it has to be **right**

Leica
Geosystems

Introduction

Purchase

Congratulations on the purchase of a Leica BLK360 series instrument.



This manual contains important safety directions as well as instructions for setting up the product and operating it. Refer to "1 Safety Directions" for further information. Read carefully through the User Manual before you switch on the product.

To ensure safety when using accompanying battery charger, also observe the directions and instructions contained in the User Manual of the battery charger.

Product Identification

The model and serial number of your product are indicated on the type plate. Always refer to this information when you need to contact your agency or Leica Geosystems authorised service centre.

Leica Geosystems Address Book

On the last page of this manual, you can find the address of Leica Geosystems headquarters. For a list of regional contacts, please visit http://leica-geosystems.com/contact-us/sales_support.

Table of Contents

In this manual	Chapter	Page
1	Safety Directions	5
1.1	General Introduction	5
1.2	Definition of Use	5
1.3	Limits of Use	6
1.4	Responsibilities	6
1.5	Hazards of Use	6
1.6	Laser Classification	9
1.6.1	General	9
1.6.2	Scanning Laser	9
1.7	Electromagnetic Compatibility EMC	10
1.8	FCC Statement, Applicable in U.S.	11
1.9	IC Statement, Applicable in Canada	12
2	Description of the System	13
2.1	System Components	13
2.2	Container Contents	13
2.3	Instrument Components	14
3	User Interface	15
3.1	Power Button	15
3.2	Device Status	15
4	Operation	17
4.1	Instrument Setup	17
4.1.1	General Information	17
4.1.2	Tripod Setup	17
4.1.3	Floor Stand Setup	18
4.2	Operation - Getting Started	18
4.3	Imaging	20
4.4	Scanning	20
4.4.1	Ambient Conditions	20
4.4.2	Troubleshooting	21
4.4.3	Field of View (FoV)	22
4.5	Data Transfer	22
4.6	Power Supply	22
4.6.1	Battery and Charger Safety	22
4.6.2	Charging Station	23
4.6.3	Internal Battery	25
5	Care and Transport	26
5.1	Maintenance	26
5.2	Transport	26
5.3	Storage	26
5.4	Cleaning and Drying	27
5.5	Glass Cleaning Procedure	27
6	Technical Data	28
6.1	General Technical Data of the Instrument	28
6.2	System Performance	28
6.3	Laser System Performance	29
6.4	Electrical Data	30
6.5	Environmental Specifications	30

	6.5.1	BLK360	30
	6.5.2	Charger and Batteries	31
6.6		Dimensions	31
6.7		Weight	31
6.8		Accessories	32
6.9		Conformity to National Regulations	32
	6.9.1	BLK360	32
	6.9.2	Dangerous Goods Regulations	33
7		Software Licence Agreement	34

1 Safety Directions

1.1 General Introduction

Description

The following directions enable the person responsible for the product, and the person who actually uses the equipment, to anticipate and avoid operational hazards.

The person responsible for the product must ensure that all users understand these directions and adhere to them.

About Warning Messages





Warning messages are an essential part of the safety concept of the instrument. They appear wherever hazards or hazardous situations can occur.

Warning messages...

- make the user alert about direct and indirect hazards concerning the use of the product.
- contain general rules of behaviour.

For the users' safety, all safety instructions and safety messages shall be strictly observed and followed! Therefore, the manual must always be available to all persons performing any tasks described here.

DANGER, WARNING, CAUTION and **NOTICE** are standardised signal words for identifying levels of hazards and risks related to personal injury and property damage. For your safety, it is important to read and fully understand the following table with the different signal words and their definitions! Supplementary safety information symbols may be placed within a warning message as well as supplementary text.

Type	Description
 DANGER	Indicates an imminently hazardous situation which, if not avoided, will result in death or serious injury.
 WARNING	Indicates a potentially hazardous situation or an unintended use which, if not avoided, could result in death or serious injury.
 CAUTION	Indicates a potentially hazardous situation or an unintended use which, if not avoided, may result in minor or moderate injury.
NOTICE	Indicates a potentially hazardous situation or an unintended use which, if not avoided, may result in appreciable material, financial and environmental damage.
	Important paragraphs which must be adhered to in practice as they enable the product to be used in a technically correct and efficient manner.

1.2 Definition of Use

Intended use

- Measuring horizontal and vertical angles.
- Measuring distances.
- Capturing and recording images.
- Recording measurements.
- Remote control of product.
- Data communication with external appliances.

Reasonably foreseeable misuse

- Use of the product without instruction.
- Use outside of the intended use and limits.
- Disabling safety systems.
- Removal of hazard notices.
- Opening the product using tools, for example screwdriver, unless this is permitted for certain functions.
- Modification or conversion of the product.
- Use after misappropriation.
- Use of products with recognizable damages or defects.
- Use with accessories from other manufacturers without the prior explicit approval of Leica Geosystems.
- Inadequate safeguards at the working site.
- Deliberate dazzling of third parties.

1.3

Limits of Use

Environment

Suitable for use in an atmosphere appropriate for permanent human habitation: not suitable for use in aggressive or explosive environments.



DANGER

Local safety authorities and safety experts must be contacted before working in hazardous areas, or close to electrical installations or similar situations by the person in charge of the product.

1.4

Responsibilities

Manufacturer of the product

Leica Geosystems AG, CH-9435 Heerbrugg, hereinafter referred to as Leica Geosystems, is responsible for supplying the product, including the user manual and original accessories, in a safe condition.

Person responsible for the product

The person responsible for the product has the following duties:

- To understand the safety instructions on the product and the instructions in the user manual.
- To ensure that it is used in accordance with the instructions.
- To be familiar with local regulations relating to safety and accident prevention.
- To inform Leica Geosystems immediately if the product and the application becomes unsafe.
- To ensure that the national laws, regulations and conditions for the operation of the product are respected.

1.5

Hazards of Use



WARNING

During dynamic applications there is a danger of accidents occurring if the user does not pay attention to the environmental conditions around, for example obstacles, excavations or traffic.

Precautions:

The person responsible for the product must make all users fully aware of the existing dangers.



WARNING

Inadequate securing of the working site can lead to dangerous situations, for example in traffic, on building sites and at industrial installations.

Precautions:

Always ensure that the working site is adequately secured. Adhere to the regulations governing safety, accident prevention and road traffic.

**CAUTION**

Watch out for erroneous measurement results if the product has been dropped or has been misused, modified, stored for long periods or transported.

Precautions:

Periodically carry out test measurements, particularly after the product has been subjected to abnormal use and before and after important measurements.

**CAUTION**

During the operation of the product, there is a hazard of squeezing extremities or entanglement of hair and/or clothes by moving parts.

Precautions:

Keep a safe distance of the moving parts.



If the instrument moves unexpectedly during operation, stop the instrument via user interface (display, key) or alternatively remove the battery or main power source to prevent further movements.

**CAUTION**

If the accessories used with the product are not properly secured and the product is subjected to mechanical shock, for example blows or falling, the product may be damaged or people can sustain injury.

Precautions:

When setting up the product, make sure that the accessories are correctly adapted, fitted, secured, and locked in position.

Avoid subjecting the product to mechanical stress.

**WARNING**

High mechanical stress, high ambient temperatures or immersion into fluids can cause leakage, fire or explosions of the batteries.

Precautions:

Protect the batteries from mechanical influences and high ambient temperatures. Do not drop or immerse batteries into fluids.

**WARNING**

If battery terminals are short circuited e.g. by coming in contact with jewellery, keys, metallised paper or other metals, the battery can overheat and cause injury or fire, for example by storing or transporting in pockets.

Precautions:

Make sure that the battery terminals do not come into contact with metallic objects.

**CAUTION**

During the transport, shipping or disposal of batteries it is possible for inappropriate mechanical influences to constitute a fire hazard.

Precautions:

Before shipping the product or disposing of it, discharge the batteries by running the product until they are flat.

When transporting or shipping batteries, the person in charge of the product must ensure that the applicable national and international rules and regulations are observed. Before transportation or shipping contact your local passenger or freight transport company.



WARNING

If the product is improperly disposed of, the following can happen:

- If polymer parts are burnt, poisonous gases are produced which may impair health.
- If batteries are damaged or are heated strongly, they can explode and cause poisoning, burning, corrosion or environmental contamination.
- By disposing of the product irresponsibly you may enable unauthorised persons to use it in contravention of the regulations, exposing themselves and third parties to the risk of severe injury and rendering the environment liable to contamination.

Precautions:

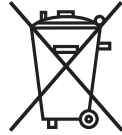

The product must not be disposed with household waste.

Dispose of the product appropriately in accordance with the national regulations in force in your country.

Always prevent access to the product by unauthorised personnel.

Product-specific treatment and waste management information can be received from your Leica Geosystems distributor.



WARNING

If the product is used with accessories, for example masts, staffs, poles, you may increase the risk of being struck by lightning.

Precautions:

Do not use the product in a thunderstorm.



Applies only for California.

The product contains CR Lithium Cell(s) with perchlorate material inside – special handling may apply. See <http://www.dtsc.ca.gov/hazardouswaste/perchlorate/>



WARNING

Only Leica Geosystems authorised service centres are entitled to repair these products.



WARNING

For the AC/DC power supply and the battery charger:

If you open the product, either of the following actions may cause you to receive an electric shock:

- Touching live components.
- Using the product after incorrect attempts were made to carry out repairs.

Precautions:

Do not open the product. Only Leica Geosystems authorised service centres are entitled to repair these products.



WARNING

For the AC/DC power supply and the battery charger:

The product is not designed for use under wet and severe conditions. If unit becomes wet it may cause you to receive an electric shock.

Precautions:

Use the product only in dry environments, for example in buildings or vehicles. Protect the product against humidity. If the product becomes humid, it must not be used!



1.6

Laser Classification

1.6.1

General

General

The following chapters provide instructions and training information about laser safety according to international standard IEC 60825-1 (2014-05) and technical report IEC TR 60825-14 (2004-02). The information enables the person responsible for the product and the person who actually uses the equipment, to anticipate and avoid operational hazards.



According to IEC TR 60825-14 (2004-02), products classified as laser class 1, class 2 and class 3R do not require:

- laser safety officer involvement,
- protective clothes and eyewear,
- special warning signs in the laser working area

if used and operated as defined in this User Manual due to the low eye hazard level.



National laws and local regulations could impose more stringent instructions for the safe use of lasers than IEC 60825-1 (2014-05) and IEC TR 60825-14 (2004-02).

1.6.2

Scanning Laser

General

The laser incorporated in the product produces an invisible beam which emerges from the rotating mirror.

The laser product described in this section is classified as laser class 1 in accordance with:

- IEC 60825-1 (2014-05): "Safety of laser products"

These products are safe under reasonably foreseeable conditions of operation and are not harmful to the eyes provided that the products are used and maintained in accordance with this User Manual.

Description	Value
Wavelength	830 nm
Maximum pulse energy	5 nJ
Pulse duration	4 ns
Pulse repetition frequency (PRF)	2.16 MHz
Beam divergence (FWHM, full angle)	0.4 mrad
Mirror rotation	30 Hz
Base rotation	2.5 mHz

Labelling

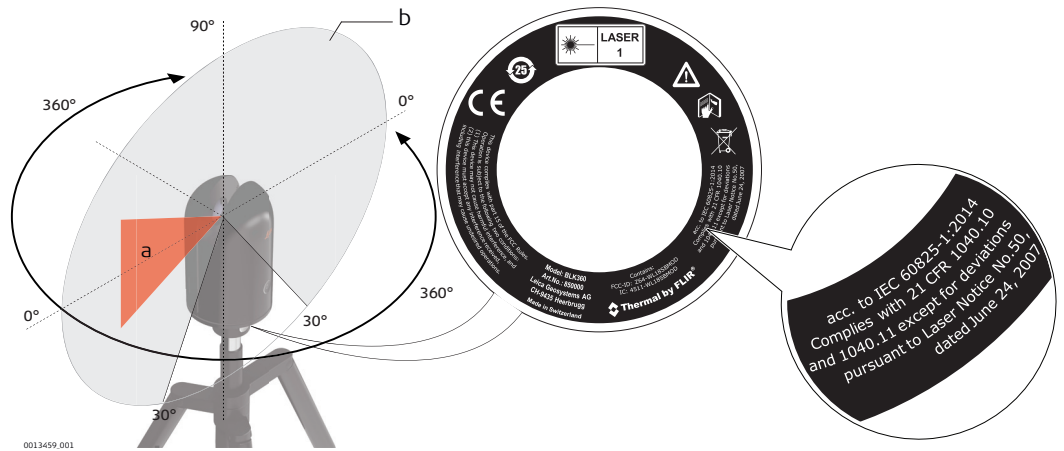

- a) Laser beam
- b) Scanning laser beam

Class 1 Laser Product
according to IEC 60825-1
(2014-05)

1.7 Electromagnetic Compatibility EMC

Description

The term Electromagnetic Compatibility is taken to mean the capability of the product to function smoothly in an environment where electromagnetic radiation and electrostatic discharges are present, and without causing electromagnetic disturbances to other equipment.

! WARNING

Electromagnetic radiation can cause disturbances in other equipment.

Although the product meets the strict regulations and standards which are in force in this respect, Leica Geosystems cannot completely exclude the possibility that other equipment may be disturbed.

! CAUTION

There is a risk that disturbances may be caused in other equipment if the product is used with accessories from other manufacturers, for example field computers, personal computers or other electronic equipment, non-standard cables or external batteries.

Precautions:

Use only the equipment and accessories recommended by Leica Geosystems. When combined with the product, they meet the strict requirements stipulated by the guidelines and standards. When using computers or other electronic equipment, pay attention to the information about electromagnetic compatibility provided by the manufacturer.

! CAUTION

Disturbances caused by electromagnetic radiation can result in erroneous measurements.

Although the product meets the strict regulations and standards which are in force in this respect, Leica Geosystems cannot completely exclude the possibility that the product may be disturbed by intense electromagnetic radiation, for example, near radio transmitters, two-way radios or diesel generators.

Precautions:

Check the plausibility of results obtained under these conditions.

Radios or Digital Cellular Phones



WARNING

Use of product with radio or digital cellular phone devices:

Electromagnetic fields can cause disturbances in other equipment, in installations, in medical devices, for example pacemakers or hearing aids and in aircraft. It can also affect humans and animals.

Precautions:

Although the product meets the strict regulations and standards which are in force in this respect, Leica Geosystems cannot completely exclude the possibility that other equipment can be disturbed or that humans or animals can be affected.

- Do not operate the product with radio or digital cellular phone devices in the vicinity of filling stations or chemical installations, or in other areas where an explosion hazard exists.
- Do not operate the product with radio or digital cellular phone devices near to medical equipment.
- Do not operate the product with radio or digital cellular phone devices in aircraft.

1.8

FCC Statement, Applicable in U.S.



WARNING

This equipment has been tested and found to comply with the limits for a Class B digital device, pursuant to part 15 of the FCC rules.

These limits are designed to provide reasonable protection against harmful interference in a residential installation.

This equipment generates, uses and can radiate radio frequency energy and, if not installed and used in accordance with the instructions, may cause harmful interference to radio communications. However, there is no guarantee that interference will not occur in a particular installation.

If this equipment does cause harmful interference to radio or television reception, which can be determined by turning the equipment off and on, the user is encouraged to try to correct the interference by one or more of the following measures:

- Reorient or relocate the receiving antenna.
- Increase the separation between the equipment and the receiver.
- Connect the equipment into an outlet on a circuit different from that to which the receiver is connected.
- Consult the dealer or an experienced radio/TV technician for help.



WARNING

Changes or modifications not expressly approved by Leica Geosystems for compliance could void the user's authority to operate the equipment.

Labelling

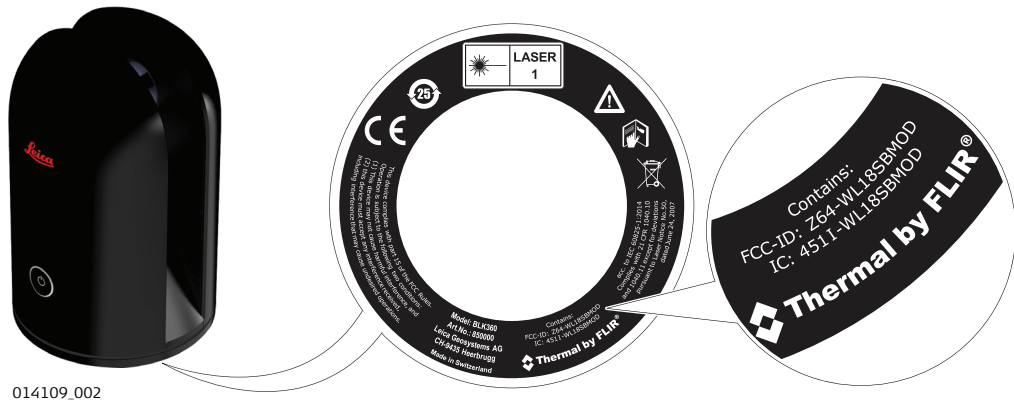

Labelling GEB212

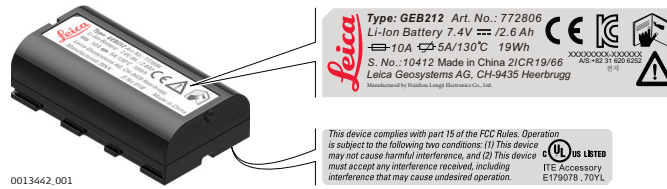

Type Plate Labelling GKL312

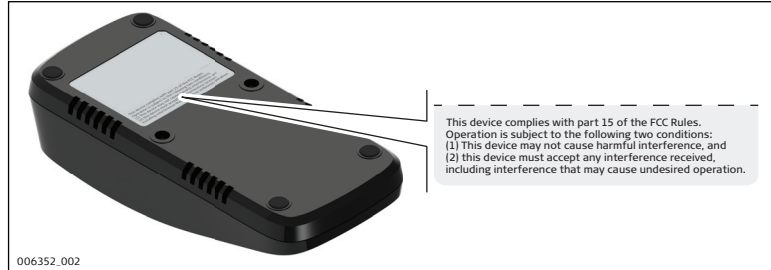

1.9

IC Statement, Applicable in Canada



WARNING

This Class (B) digital apparatus complies with Canadian ICES-003.
Cet appareil numérique de la classe (B) est conforme à la norme NMB-003 du Canada.

Canada Compliance Statement

This device complies with Industry Canada's licence-exempt RSS 247. Operation is subject to the following two conditions:

- 1) This device may not cause interference; and
- 2) This device must accept any interference, including interference that may cause undesired operation of the device.

Canada Déclaration de Conformité

Le présent appareil est conforme aux CNR 247 d'Industrie Canada applicables aux appareils radio exempts de licence. L'exploitation est autorisée aux deux conditions suivantes:

- 1) l'appareil ne doit pas produire de brouillage;
- 2) l'appareil doit accepter tout brouillage radioélectrique subi, même si le brouillage est susceptible d'en compromettre le fonctionnement.

2 Description of the System

2.1 System Components

System components BLK360



013446_001

- a) BLK360 instrument and hood with floor stand
- b) GEB212 batteries
- c) GKL312 charging station
- d) GEV192-9 AC/DC power supply for GKL312
- e) BLK360 mission bag
- f) BLK360 tripod adapter
- g) Tripod

2.2 Container Contents

Container contents

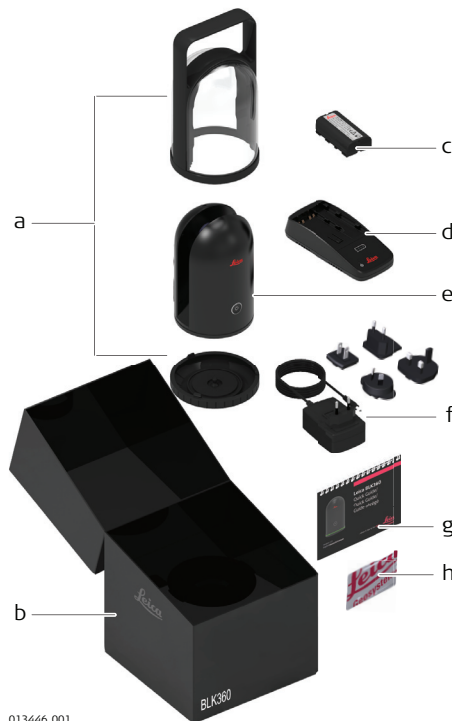

013446_001

- a) BLK360 hood with floor stand
- b) BLK360 box
- c) GEB212 internal battery
- d) GKL312 charging station
- e) BLK360
- f) GEV192-9 AC/DC power supply for GKL312
- g) BLK360 Quick Guide
- h) BLK360 System USB swing card

2.3

Instrument Components

Instrument components

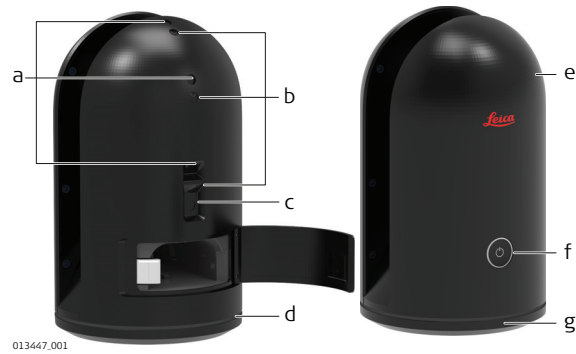

013447_001

- a) Flash light for HDR camera
- b) HDR camera
- c) IR camera
- d) Ring-shaped LED
- e) Scanner 360 °
- f) Power button
- g) 360 ° WLAN antenna

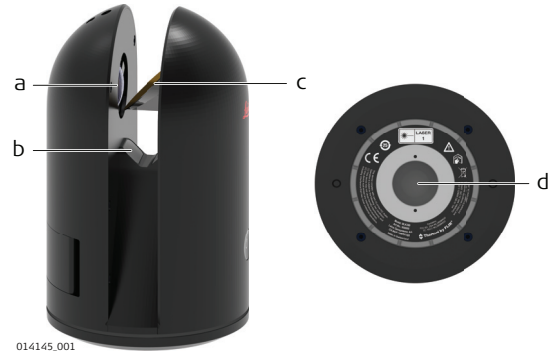

014145_001

- a) Laser aperture
- b) Nadir reference plate
- c) Rotating prism
- d) Quick release mount

3 User Interface

3.1 Power Button

Power button



013456.001

a) Power button

Power button	when the BLK360 is	THEN
Press and hold the button <0.5 sec.	off.	The BLK360 switches on and the LED starts blinking yellow.
Press and hold the button <0.5 sec.	on and ready. The LED is continuous green.	After counting down for 10 seconds the BLK360 starts recording and the LED starts blinking yellow.
Press and hold the button <0.5 sec.	in Power Safe mode. The LED is off.	The BLK360 is ready again. The LED turns to continuous green.
Press and hold the button >2 sec.	on and ready. The LED is continuous green.	The LED starts blinking yellow and the BLK360 switches off.
Press and hold the button > 5 sec.	on.	The BLK360 switches off immediately. Hard shutdown.

NOTICE

It is mandatory to follow always this procedure to shut down the instrument. Do not remove the battery from a running instrument!

3.2 Device Status





Device status

The ring-shaped LED lights up green, yellow or red in different intervals to show the operation states of the BLK360.





- a) Ring-shaped LED continuous
- b) Ring-shaped LED blinking
- c) Ring-shaped LED alternating

Operation mode

LED status	Instrument status
	The BLK360 is off or in Power Safe mode.
	The BLK360 is starting, recording or switching off.
	The BLK360 is ready. Bright green: Battery capacity > 20%. Dark green: Battery capacity < 20%. In case of low battery, refer to Insert and remove the internal battery .
	The BLK360 is counting down before recording. The countdown time is 10 seconds.

Firmware update mode

LED status	Instrument status
	The BLK360 is running a firmware update.
	The firmware update was successful.
	The firmware update failed.

 Refer to the help menu in the Leica BLK360 app for details about firmware update process.

4

Operation

4.1



Instrument Setup

4.1.1

General Information

Use the tripod

The instrument should always be set up on its floor stand or tripod. Using the tripod specified for the scanning system guarantees maximum stability during scanning operations.

-  Do not set up the instrument directly on the ground without the floor stand or tripod connected.
-  It is always recommended to shield the instrument from direct sunlight and avoid uneven temperatures around the instrument.

4.1.2

Tripod Setup

BLK360 setup step-by-step

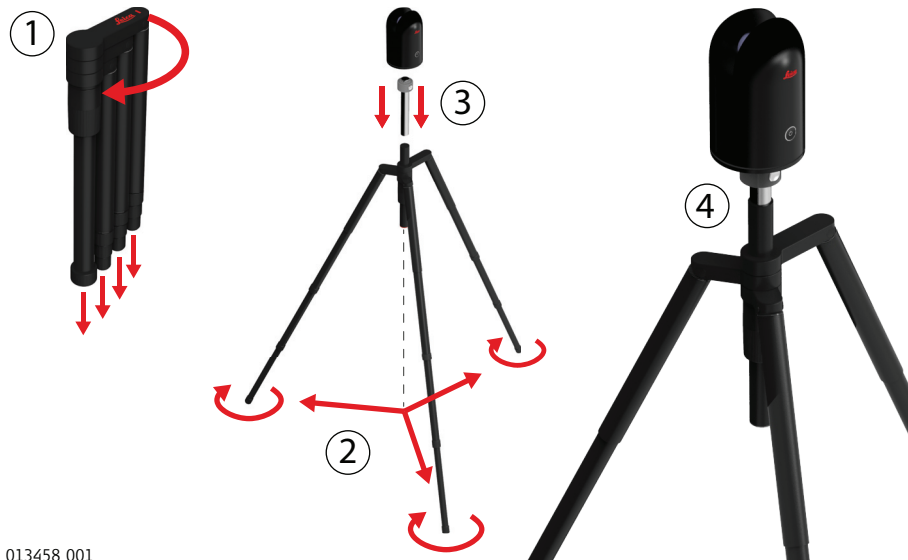

013458_001

Step	Description
1.	Unfold the tripod and extend the tripod legs to allow for a comfortable working posture.
2.	Tighten the screws at the bottom of the legs and expand the legs for a stable tripod position.
3.	Place the tripod adapter on the tripod and secure it.
4.	Place the instrument on the tripod adapter and secure it.

4.1.3

Floor Stand Setup

BLK360 setup step-by-step



Step	Description
1.	Open the BLK360 hood.
2.	Turn around the bottom plate by 180 degrees.
3.	Place the BLK360 on the bottom plate.

4.2

Operation - Getting Started

Stand-alone operation step-by-step

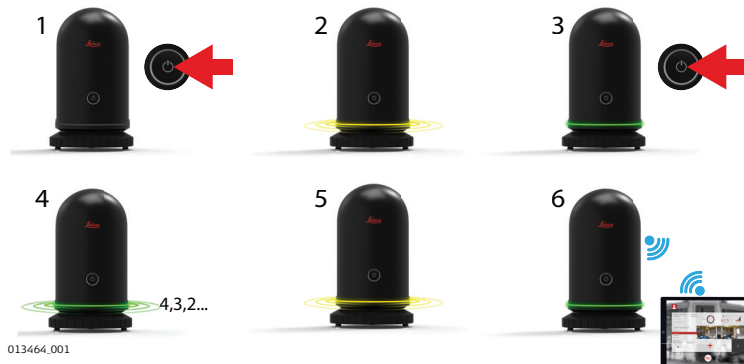

Step	Description
1.	Press the power button to turn on the BLK360.
2.	The BLK360 is starting. The ring-shaped LED is blinking yellow.
3.	If the ring-shaped LED is continuous green, the BLK360 is ready for operation. Press the power button to start recording.
4.	The BLK360 is counting down for 10 seconds before recording. The ring-shaped LED is blinking green.
5.	Recording starts. The ring-shaped LED is blinking yellow.
6.	The recording is finished. The ring-shaped LED is continuous green. The data transfer starts as soon as the BLK360 is linked to a computing device.

 Do not touch or move the BLK360 while the system is recording.



Operation with computing device connection step-by-step



Step	Description
1.	Press the power button to turn on the BLK360.
2.	The BLK360 is starting. The ring-shaped LED is blinking yellow.
3.	If the ring-shaped LED is continuous green, the BLK360 is ready for operation. Press the power button to start recording.
4.	Connect the computing device with the BLK360.
5.	Start the recording and simultaneous data transfer via computing device. The ring-shaped LED is blinking yellow.
6.	Start the processing of data on the computing device.

Connecting to a computing device step-by-step



Step	Description
1.	Start the BLK360 and wait until the LED is continuous green.
2.	On the computing device select Settings and tap Wi-Fi .
3.	Select the network BLK360-35xxxxx in the Wi-Fi settings to be connected.  The number 35xxxxx is the serial number of the BLK360.
4.	Enter the password.  The instrument specific password is printed on the label in the battery compartment (e.g. COL-123-456-789)
5.	Start the app and connect the instrument.

 For further information, refer to the help menu in the app.

4.3

Imaging

Description

The BLK360 can collect panoramic, 360 ° spheric image data with three calibrated cameras.

Imaging

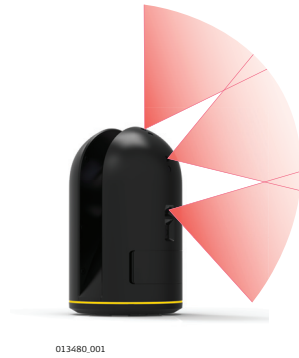

a) 3 cameras

4.4

Scanning

4.4.1

Ambient Conditions

Unfavourable surfaces for scanning

- Highly reflective (polished metal, gloss paint)
- Highly absorbent (black)
- Translucent (clear glass)

👉 Colour, powder or tape these surfaces before scanning if necessary.

Unfavourable weather conditions for scanning

- Rain, snow or fog may adversely affect measurement quality. Always use care when surveying in these conditions.
- Surfaces that are directly illuminated by the sun cause an increased range noise and therefore a larger measurement uncertainty.
- If some objects are scanned against the sunlight or a bright spotlight, the optical receiver of the instrument can be dazzled so heavily that in this area no measured data is recorded. A "black hole" appears in the reflectance image.

Temperature changes during scanning

If the instrument is brought from a cold environment, for example from storage, into a warm and humid environment, the mirror or in extreme cases even the interior optics can condensate. This may cause measurement errors.

👉 Precaution: Avoid rapid temperature changes and give the instrument time to acclimatise.

Dirt on the mirror

Dirt on the mirror such as a layer of dust, condensation or fingerprints may cause considerable measuring errors.



Basic trouble-shooting

Problem	Possible Cause(s)	Suggested Remedies
Missing points in scan.	Dust, debris or fingerprints on rotating mirror.	Use glass cleaning tissue to clean the specific areas.

Advanced trouble-shooting

Problem	Possible Cause(s)	Suggested Remedies
When switching on the instrument or starting a scan, the system switches off automatically.	Capacity of battery is too low.	Recharge or change battery.
When switching on the instrument or starting a scan, the system switches off automatically even though it was totally recharged.	Battery charger is defective.	Check the function of the battery charger. Please note the charging status displayed on the battery charger.
	Internal battery is no longer charging.	At the end of its life time the internal battery has lost most of its capacity. The battery needs to be replaced.

Troubleshooting-operation mode

LED status	Instrument status
	System warning. For example, full storage device, empty battery. Shut down the instrument and reboot again. If status does not change, check internal storage capacity and power status of battery. Delete data and/or exchange battery.
	An unrecoverable system error occurred. Shut down the instrument and reboot again. If status does not change, contact the Leica support.

Troubleshooting - support contacts

If you experience problems with your instrument, check the BLK360 web page at <http://www.lasers.leica-geosystems.com/blk360> for support information and contacts.

4.4.3

Field of View (FoV)

Scanning laser - field of view

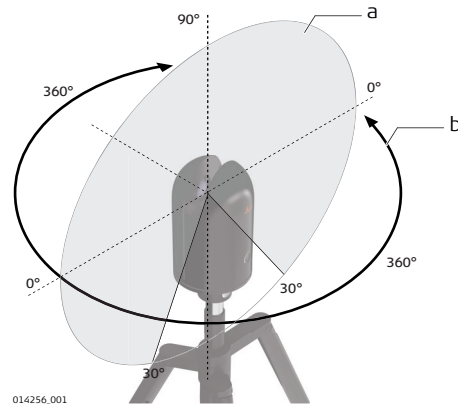

- a) Vertical field of view: 300°
b) Horizontal field of view: 360°

4.5

Data Transfer

Description



- a) Raw data transfer from BLK360 to computing device. Refer to **Operation - Getting Started**.

4.6

Power Supply

4.6.1

Battery and Charger Safety

General

Use the batteries, chargers and accessories recommended by Leica Geosystems to ensure the correct functionality of the instrument.

First-time Use/Charging Batteries

- The battery must be charged before using it for the first time because it is delivered with an energy content as low as possible.
- The permissible temperature range for charging is from 0 °C to +40 °C/+32 °F to +104 °F. For optimal charging, we recommend charging the batteries at a low ambient temperature of +10 °C to +20 °C/+50 °F to +68 °F if possible.
- It is normal for the battery to become warm during charging. Using the chargers recommended by Leica Geosystems, it is not possible to charge the battery once the temperature is too high.
- For new batteries or batteries that have been stored for a long time (> three months), it is effectual to make only one charge/discharge cycle.
- For Li-Ion batteries, a single discharging and charging cycle is sufficient. We recommend carrying out the process when the battery capacity indicated on the charger or on a Leica Geosystems product deviates significantly from the actual battery capacity available.

Operation / Discharging

- The batteries can be operated from $-20\text{ }^{\circ}\text{C}$ to $+55\text{ }^{\circ}\text{C}$ / $-4\text{ }^{\circ}\text{F}$ to $+131\text{ }^{\circ}\text{F}$.
- Low operating temperatures reduce the capacity that can be drawn; high operating temperatures reduce the service life of the battery.

4.6.2

Charging Station

Main components



Power supply

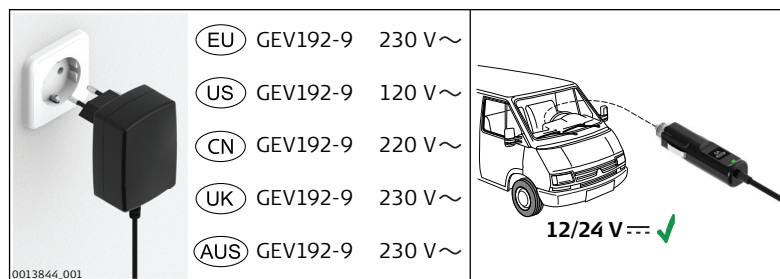

Charging times

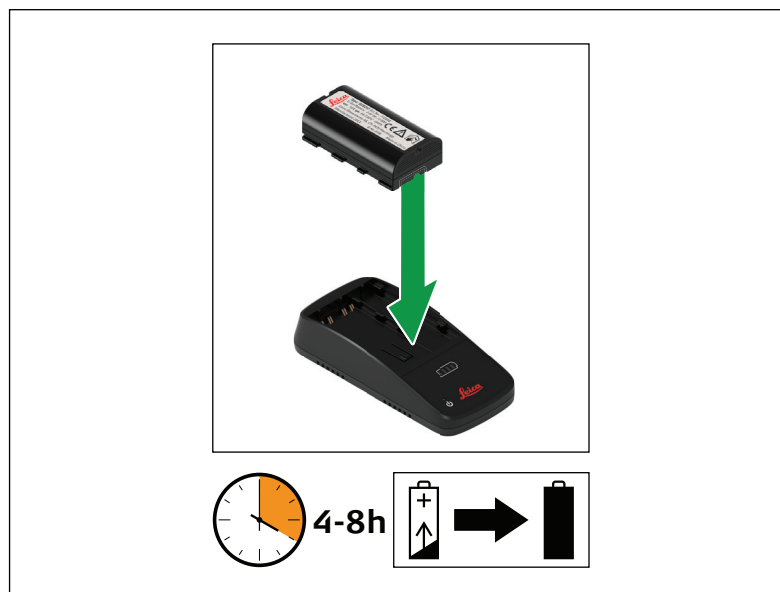

Connecting the charger

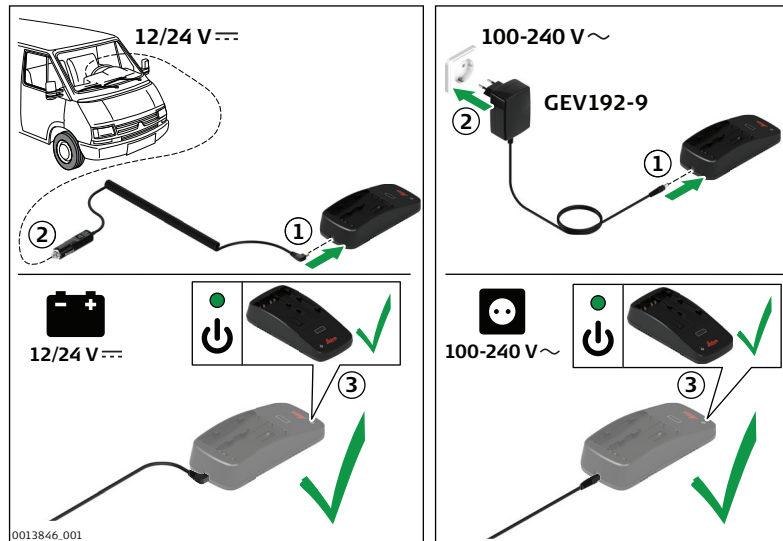

Inserting and charging the battery

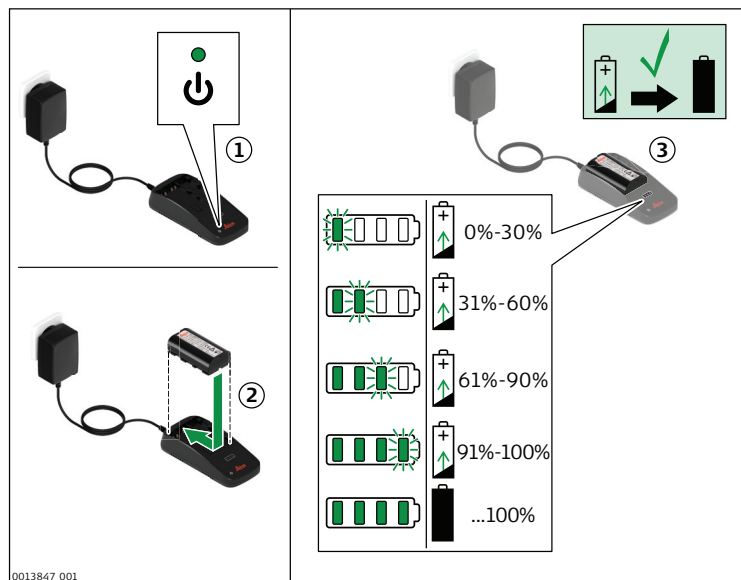

Error indication

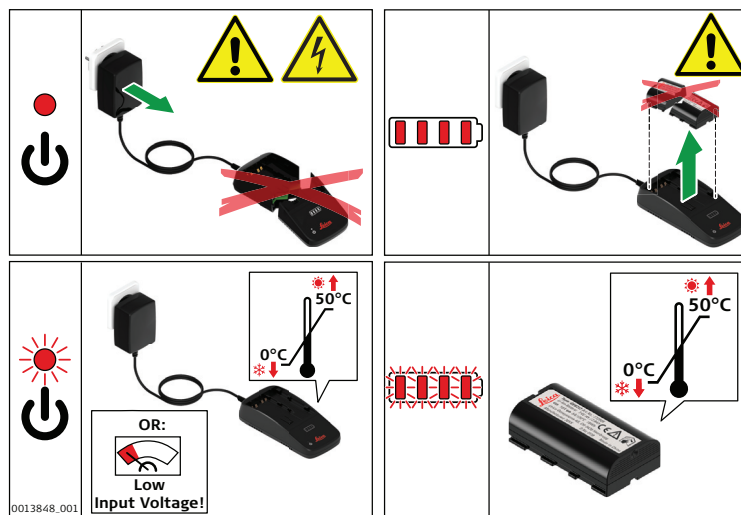

4.6.3

Internal Battery

Insert and remove the internal battery

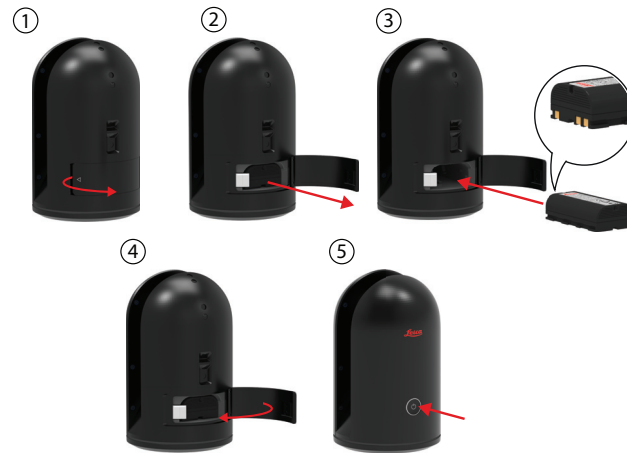

0014147.001

Step	Description
1.	Open the battery compartment.
2.	Remove the battery from the battery compartment.
3.	Insert the new battery into the battery compartment.  Ensure that the battery contacts are facing inwards.
4.	Close the battery compartment.
5.	Turn on the BLK360 to start the boot process.

NOTICE

Always shut down the instrument before removing the battery.

5 Care and Transport

5.1 Maintenance



For units that are exposed to high mechanical forces, for example through frequent transport or rough handling, it is recommended to carry out test measurements periodically.

5.2 Transport

Transport in the field

When transporting the equipment in the field, always make sure that you carry the product in its original transport container or carry the tripod upright with the product fastened and secured onto the tripod.

Transport in a road vehicle

Never carry the product loose in a road vehicle, as it can be affected by shock and vibration. Always carry the product in its container, original packaging or equivalent and secure it.

Shipping

When transporting the product by rail, air or sea, always use the complete original Leica Geosystems packaging, container and cardboard box, or its equivalent, to protect against shock and vibration.

Shipping, transport of batteries

When transporting or shipping batteries, the person responsible for the product must ensure that the applicable national and international rules and regulations are observed. Before transportation or shipping, contact your local passenger or freight transport company.

5.3 Storage

Product

Respect the temperature limits when storing the equipment, particularly in summer if the equipment is inside a vehicle. Refer to "6 Technical Data" for information about temperature limits.

- Refer to "Environmental Specifications" for information about storage temperature range.
 - Remove batteries from the product and the charger before storing.
 - After storage recharge batteries before using.
 - Protect batteries from damp and wetness. Wet or damp batteries must be dried before storing or use.
 - A storage temperature range of 0°C to +30°C/+32°F to 86°F in a dry environment is recommended to minimise self-discharging of the battery.
 - At the recommended storage temperature range, batteries containing a 40% to 50% charge can be stored for up to one year. After this storage period the batteries must be recharged.
-

5.4

Cleaning and Drying

Damp products

Dry the product, the mission bag, the foam inserts and the accessories at a temperature not greater than 40°C /104°F and clean them. Remove the battery cover and dry the battery compartment. Do not repack until everything is completely dry. Always close the mission bag when using in the field.

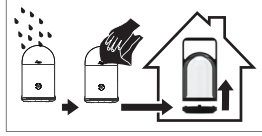

Housing parts of product and accessories

- Never touch the glass and scanning mirror with your fingers.
- Use only a clean, soft, lint-free cloth for cleaning. If necessary, moisten the cloth with water or pure alcohol. Do not use other liquids; these may attack the polymer components.

Charger and AC/DC power supply

Use only a clean, soft, lint-free cloth for cleaning.

Cables and plugs

Keep plugs clean and dry. Blow away any dirt lodged in the plugs of the connecting cables.

5.5

Glass Cleaning Procedure

General cleaning information

The scanning mirror must be kept clean. The instructions must be followed as described in this chapter to clean the scanner mirror.



CAUTION

Before any cleaning procedure, ensure that the instrument is switched off and the battery has been removed.

Dust and debris on optical surfaces

Using a compressed gas duster (e.g., UltraJet® 2000 Gas Duster or UltraJet® Compressed CO2 Duster), remove dust and debris from surface of scanner glass.



Never rub off dust or debris as this will scratch the glass and so possibly cause permanent damage to the special optical coatings.

Cleaning of optical surfaces

Soiling of the glass pane can cause extreme measurement errors and therefore useless data!



All soiling that is visible on the glass pane has to be removed, except for single small dust particles that adhere inevitably.

For the glass cleaning procedure, the wet and dry lens cleaner Green Clean LC-7010 is recommended (www.green-clean.at/en.html).

Clean the glass pane regularly with the recommended cleaning tissue:

- Switch off instrument and remove the battery.
- Washing hands is necessary in order to avoid grease on the cleaning tissue.
- Better, use gloves to avoid finger oil on the glass.
- Then use the wet lens cleaning tissue (Green Clean LC-7010) until there is only a thin film of detergent visible.
- After that use the dry lens cleaning tissue (Green Clean LC-7010) to remove any remaining detergent.
- If any smears from cleaning are visible against back light, repeat the procedure.
- Do not use air from the pneumatic power system as this is always slightly oily!

6 Technical Data

6.1 General Technical Data of the Instrument

Storage and Communication

Internal storage:
64 GB, enough for > 100 setups.

Communication:
Integrated 802.11 b/g/n WLAN with MIMO.

Internal HDR cameras

The Leica BLK360 has three integrated HDR digital cameras.

Camera data	Value
Type	Colour sensor, fixed focal length
Single image	2592 x 1944 pixels, 60° x 45° (V x Hz)
Full dome	30 images, automatically spatially rectified, 150Mpx, 360° x 300°
White balancing	Automatic
HDR	Automatic
Flash	LED for continuous illumination
Minimum range	0.6 m

Internal thermal camera

The Leica BLK360 has an integrated thermal camera.

Camera data	Value
Type	FLIR
Single image	160 x 120 pixels, 71° x 56° (V x Hz)
Full dome	10 images, 360° x 70°
Temperature range	-10 °C to 65 °C
Thermal sensitivity	< 0.05 °C
Spectral range	8 to 14 µm
Minimum range	0.6 m

6.2 System Performance

System performance and accuracy

 All ± accuracy specifications are one sigma (1σ) unless otherwise noted.

Accuracy of single measurement (at 78% albedo)	Value
3D point accuracy	6 mm at 10 m, 8 mm at 20 m

Laser scanning system data

 The scanning system is a high speed time-of-flight unit, enhanced by Waveform Digitising (WFD) technology with a maximum scan rate of 360.000 points/second.

Laser unit:

Scanning laser	Value
Classification	Laser Class 1 (in accordance with IEC 60825-1 (2014-05))
Wavelength	830 nm (invisible)

Range:

Scanning data	Value
Beam divergence	0.4 mrad (FWHM, full angle)
Beam diameter at front window	2.25 mm (FWHM)
Minimum range	0.6 m
Maximum range	60 m @ 78% albedo
Range accuracy	4 mm at 10 m and 7 mm at 20 m

Field-of-View (per scan):

Field-of-View	Value
Selection	Always full dome.
Horizontal	360°
Vertical	300°
Scanning optics	Vertically rotating mirror on horizontally rotating base.

Scan duration for 3 settings:

Point density mode	Resolution [mm @ 10 m]	Estimated scan duration [MM:SS] for a full dome scan
Fast	20	00:40
Standard	10	01:50
High density	5	03:40

Image capturing time:

Camera type	Estimated image duration [MM:SS]
Imaging	01:40

Scan size for 3 settings:

Resolution [mm @ 10 m]	Approx. scan size [mio points]
Fast	3
Standard	18
High density	65

6.4

Electrical Data

BLK360 power supply and consumption

Power supply:

Internal battery
7.4V DC; one internal battery provided with system.

Power consumption:

Instrument
10 W typical; 16 W max.

GKL312 charging station

Supply	Value
Input voltage	10-32 V DC

GEB212 internal battery

Supply	Value
Type	Li-Ion
Voltage	7.4 V
Capacity	2.6 Ah

Battery operating and charging times

Internal battery	Value
Operating time	> 40 setups per battery, typical continuous use (room temperature).
Charging time	Typical charging time with charger GKL312 is 4-8 hours at room temperature.

6.5

Environmental Specifications

6.5.1

BLK360

Environmental specifications BLK360

Temperature range:

Type	Operating temperature [°C]	Storage temperature [°C]
Instrument	+5 to +40	-25 to +70

Protection against water, dust and sand:

Type	Protection
Instrument	IP54 (IEC 60529), upright Dust protected Protection against splashing water from any direction

Humidity:

Type	Protection
Instrument	Max 95 % non condensing

Lighting:

Type	Conditions
Instrument	Fully operational from bright sunlight to complete darkness.

6.5.2

Charger and Batteries

Charger and battery specifications

Temperature range for GKL312 and GEB212

Operating temperature [°C]	Mode
0 to +50	Charging
-20 to +55	Discharging

Storage temperature [°C]

-40 to +70

Protection against water, dust, sand and humidity

Type	Protection
Battery	IP54 (IEC 60529) Dust protected Protection against splashing water from any direction. Humidity max. 95% non condensing.

Type	Protection
Charger and AC/DC power supply	Only operate in dry environments, for example in buildings and vehicles.

6.6

Dimensions

Dimensions

Instrument	Dimensions [mm] (D x W x H)	Dimensions ["] (D x W x H)
Leica BLK360	100 x 100 x 165	3.9 x 3.9 x 6.5
GEV192-9 AC power supply for charging station GKL312	85 x 170 x 41 / cable length: 1800	3.4 x 6.7 x 1.6 / cable length: 70
GKL312 charging station	157 x 71 x 38	6.2 x 2.8 x 1.5
GEB212 battery	71.5 x 39.5 x 21.2	2.8 x 1.6 x 0.8
Transport container	195.5 x 195.5 x 258.6	7.7 x 7.7 x 10.2

6.7

Weight

Weight

Instrument	Weight [kg]	Weight [lbs]
Leica BLK360	1.0 nominal	2.2 nominal
GEV192-9 AC power supply for GKL312	0.1	0.3
GKL312 charging station	0.1	0.3
GEB212 battery	0.1	0.3
Leica BLK360 transport container (without scanner and accessories)	1.0	2.3
Leica BLK360 transport container (with scanner and standard accessories)	3.0	6.7

6.8

Accessories

Scope of delivery

Included standard accessories:

- BLK360 hood
- Battery charger GKL312 with AC power adapter GEV192-9
- Battery GEB212 (1x)
- Quick guide BLK360
- Quick guide GKL312
- 12 month warranty
- Calibration certificate digital access via online registration

Additional accessories

- additional batteries GEB212
- BLK360 tripod
- BLK360 tripod adapter
- BLK360 mission bag

6.9

Conformity to National Regulations

6.9.1

BLK360

Conformity to national regulations

- FCC Part 15 (applicable in US)
- Hereby, Leica Geosystems AG, declares that the product BLK360 is in compliance with the essential requirements and other relevant provisions of Directive 1999/5/EC. The declaration of conformity can be consulted at <http://www.leica-geosystems.com/ce>.



Class 1 equipment according European Directive 1999/5/EC (R&TTE) can be placed on the market and be put into service without restrictions in any EEA member state.

- The conformity for countries with other national regulations not covered by the FCC part 15 or European directive 1999/5/EC has to be approved prior to use and operation.
- Japanese Radio Law and Japanese Telecommunications Business Law Compliance.
 - This device is granted pursuant to the Japanese Radio Law (電波法) and the Japanese Telecommunications Business Law (電気通信事業法).
 - This device should not be modified (otherwise the granted designation number will become invalid).

Frequency band

Type	Frequency band [MHz]
WLAN	2412 - 2462

Output power



Type	Output power [mW]
WLAN	100 max.

Antenna

Type	Antenna	Gain [dBi]
WLAN	Dual dipole antenna MIMO system	± 2

Dangerous Goods Regulations

Many products of Leica Geosystems are powered by Lithium batteries. Lithium batteries can be dangerous under certain conditions and can pose a safety hazard. In certain conditions, Lithium batteries can overheat and ignite.

-  When carrying or shipping your Leica product with Lithium batteries onboard a commercial aircraft, you must do so in accordance with the **IATA Dangerous Goods Regulations**.
 -  Leica Geosystems has developed **Guidelines** on “How to carry Leica products” and “How to ship Leica products” with Lithium batteries. Before any transportation of a Leica product, we ask you to consult these guidelines on our web page (<http://www.leica-geosystems.com/dgr>) to ensure that you are in accordance with the IATA Dangerous Goods Regulations and that the Leica products can be transported correctly.
 -  Damaged or defective batteries are prohibited from being carried or transported onboard any aircraft. Therefore, ensure that the condition of any battery is safe for transportation.
-

Software Licence Agreement

This product contains software that is preinstalled on the product, or that is supplied to you on a data carrier medium, or that can be downloaded by you online according to prior authorisation from Leica Geosystems. Such software is protected by copyright and other laws and its use is defined and regulated by the Leica Geosystems Software Licence Agreement, which covers aspects such as, but not limited to, Scope of the Licence, Warranty, Intellectual Property Rights, Limitation of Liability, Exclusion of other Assurances, Governing Law and Place of Jurisdiction. Please make sure, that at any time you fully comply with the terms and conditions of the Leica Geosystems Software Licence Agreement.

Such agreement is provided together with all products and can also be referred to and downloaded at the Leica Geosystems home page at <http://leica-geosystems.com/about-us/compliance-standards/legal-documents> or collected from your Leica Geosystems distributor.

You must not install or use the software unless you have read and accepted the terms and conditions of the Leica Geosystems Software Licence Agreement. Installation or use of the software or any part thereof, is deemed to be an acceptance of all the terms and conditions of such Licence Agreement. If you do not agree to all or some of the terms of such Licence Agreement, you must not download, install or use the software and you must return the unused software together with its accompanying documentation and the purchase receipt to the distributor from whom you purchased the product within ten (10) days of purchase to obtain a full refund of the purchase price.

Open source information

The software on the product may contain copyright-protected software that is licensed under various open source licences.

Copies of the corresponding licences:

- are provided together with the product (for example in the About panel of the software).
- can be downloaded on <http://opensource.leica-geosystems.com/blk360>.

If foreseen in the corresponding open source licence, you may obtain the corresponding source code and other related data on <http://opensource.leica-geosystems.com/blk360>. Contact opensource@leica-geosystems.com in case you need additional information.

853811-1.0.0en

Original text

Printed in Switzerland

© 2017 Leica Geosystems AG, Heerbrugg, Switzerland

Leica Geosystems AG

Heinrich-Wild-Strasse

CH-9435 Heerbrugg

Switzerland

Phone +41 71 727 31 31

www.leica-geosystems.com

- when it has to be **right**

Leica
Geosystems